

HERZ - prechodové koleno s vnútorným závitom

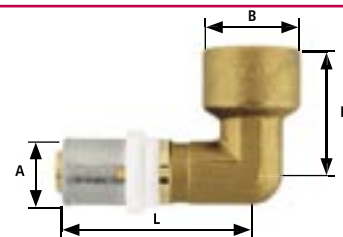

Objednávacie číslo	A	B	L	H
P 7114 21	14 x 2	1/2	53	34
P 7116 21	16 x 2	1/2	44	34
P 7118 21	18 x 2	1/2	53	34
P 7120 21	20 x 2	1/2	50	34
P 7120 22	20 x 2	3/4	52	45
P 7126 22	26 x 3	3/4	56	45
P 7132 23	32 x 3	1	55	49
P 7140 24	40 x 3,5	1¼	55	55
P 7150 24	50 x 4	1¼	76	63
P 7150 25	50 x 4	1½	76	63
P 7163 26	63 x 4,5	2	83	70

HERZ - nástenná krabica

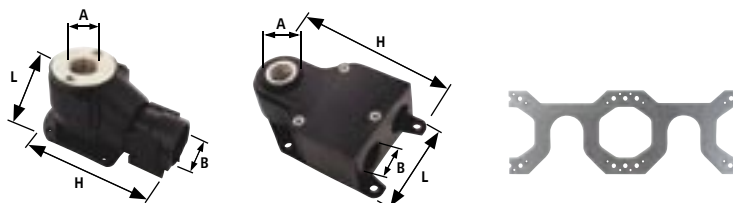

Objednávacie číslo	A	B	L	H
P 3128 18	Rp 1/2	G 3/4	55	75
P 3128 19	Rp 1/2	2 x G 3/4	80	90
P 1025 07	Montážna kolajnička pre nástennú krabicu			

HERZ - zvukovoizolačný diel pre dvojité nástenku

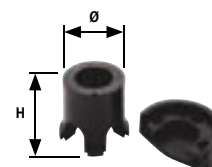

Objednávacie číslo	Ø	H
P 0450 04	40	60
P 0450 01	40	60
P 0450 02	40	60
P 0450 03	40	80

HERZ - nástenka krátka

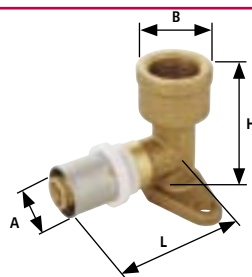

Objednávacie číslo	A	B	L	H
P 7114 31	14 x 2	1/2	45	50
P 7116 31	16 x 2	1/2	45	50
P 7118 31	18 x 2	1/2	45	50
P 7120 31	20 x 2	1/2	45	50
P 7120 32	20 x 2	3/4	45	50
P 7126 32	26 x 3	3/4	45	50

HERZ - nástenka dlhá

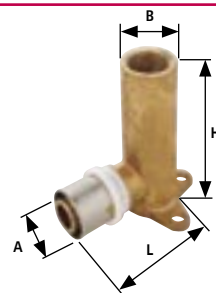

Objednávacie číslo	A	B	L	H
P 7114 41	14 x 2	1/2	50	80
P 7116 41	16 x 2	1/2	50	80
P 7118 41	18 x 2	1/2	50	80
P 7120 41	20 x 2	1/2	50	80

HERZ - sada nástieniek

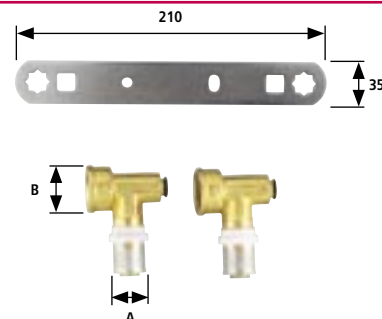

Objednávacie číslo	A	B	Sada
P 7116 56	16 x 2	1/2	konzola + 2 nástienky
P 7116 57	16 x 2	1/2	konzola 76 mm + 2 nástienky
P 7116 58	16 x 2	1/2	konzola + 1 nástienka, 2 otvory
P 7116 59	16 x 2	1/2	konzola + 1 nástienka, 3 otvory

HERZ - T-kus pre montáž nádrže splachovača pod omietku

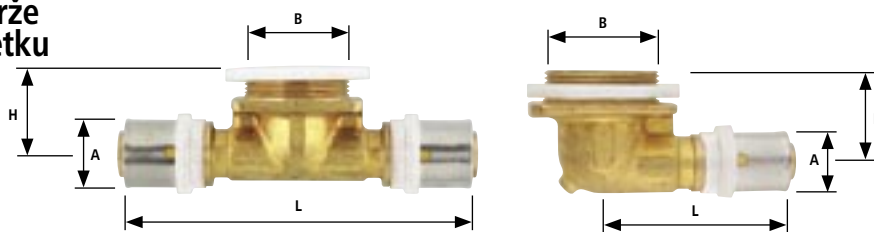

Objednávacie číslo	A	B	L	H
P 7216 61	16 x 2	Rp 1/2	120	30
P 7220 61	20 x 2	Rp 1/2	120	30
P 7114 61	14 x 2	Rp 1/2	60	25
P 7116 61	16 x 2	Rp 1/2	60	25
P 7118 61	18 x 2	Rp 1/2	60	25
P 7120 61	20 x 2	Rp 1/2	60	25

HERZ - stenová prechodka

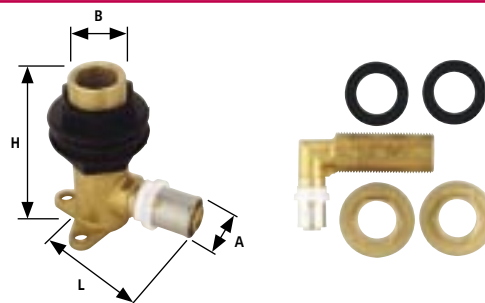

Objednávacie číslo	A	B	L	H
P 7116 51	16 x 2	Rp 1/2	50	50
P 7116 52	16 x 2	Rp 1/2	50	50
P 7118 52	18 x 2	Rp 1/2	50	80
P 7120 52	20 x 2	Rp 1/2	50	80
P 7116 53	16 x 2	Rp 1/2	50	50
P 7118 53	18 x 2	Rp 1/2	50	80
P 7120 53	20 x 2	Rp 1/2	50	80

HERZ - nástenka dvojitá, tvar U

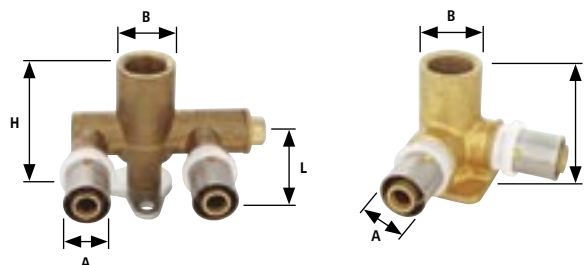

Objednávacie číslo	A	B	L	H
P 7116 38	16 x 2	Rp 1/2	55	60
P 7120 38	20 x 2	Rp 1/2	55	60
P 7116 35	16 x 2	Rp 1/2	55	60
P 7118 35	18 x 2	Rp 1/2	55	60
P 7120 35	20 x 2	Rp 1/2	55	60

HERZ - montážna koľajnica s adaptérom a s 2-mi nástenkami pre prechod stenou

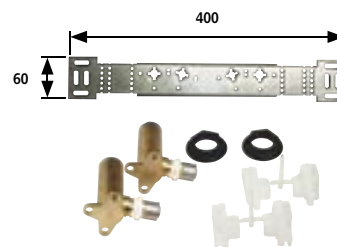

Objednávacie číslo	A	B	Vyhotovenie
P 7298 11	-	-	len montážna koľajnička
P 7298 10	-	-	Montážna koľajnička+ adaptér pre nástenku
P 7116 54	16 x 2	Rp 1/2	s 2mi ks násteniek pre prechod stenou
P 7118 54	18 x 2	Rp 1/2	s 2mi ks násteniek pre prechod stenou
P 7120 54	20 x 2	Rp 1/2	s 2mi ks násteniek pre prechod stenou
P 7116 39	16 x 2	Rp 1/2	s 2mi ks dvojitéch násteniek
P 7118 39	18 x 2	Rp 1/2	s 2mi ks dvojitéch násteniek
P 7120 39	20 x 2	Rp 1/2	s 2mi ks dvojitéch násteniek
P 7116 33	16 x 2	Rp 1/2	s 2mi ks krátkych násteniek
P 7118 33	18 x 2	Rp 1/2	s 2mi ks krátkych násteniek
P 7120 33	20 x 2	Rp 1/2	s 2mi ks krátkych násteniek
P 7116 43	16 x 2	Rp 1/2	s 2mi ks dlhých násteniek
P 7118 43	18 x 2	Rp 1/2	s 2mi ks dlhých násteniek
P 7120 43	20 x 2	Rp 1/2	s 2mi ks dlhých násteniek

HERZ - prechodové koleno s vonkajším závitom

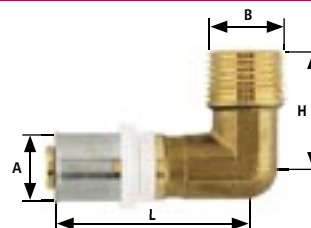

Objednávacie číslo	A	B	L	H
P 7114 11	14 x 2	1/2	53	34
P 7116 11	16 x 2	1/2	44	34
P 7118 11	18 x 2	1/2	53	34
P 7120 11	20 x 2	1/2	50	34
P 7120 12	20 x 2	3/4	50	34
P 7126 12	26 x 3	3/4	56	45
P 7132 13	32 x 3	1	55	49
P 7140 14	40 x 3,5	1¼	55	55
P 7150 14	50 x 4	1¼	76	61
P 7163 16	63 x 4,5	2	83	70

HERZ - prechodový závitový spoj s prevlečnou maticou, ploché tesnenie

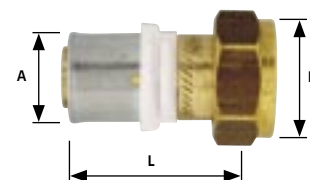

Objednávacie číslo	A	B	L
P 7014 41	14 x 2	G 3/4	45
P 7016 41	16 x 2	G 3/4	45
P 7018 41	18 x 2	G 3/4	45
P 7020 41	20 x 2	G 3/4	45
P 7016 42	16 x 2	G 1	40
P 7018 42	18 x 2	G 1	35
P 7020 42	20 x 2	G 1	40
P 7026 42	26 x 3	G 1	50
P 7026 43	26 x 3	G 1¼	50
P 7032 43	32 x 3	G 1¼	50
P 7040 43	40 x 3,5	G 1¼	70
P 7032 44	32 x 3	G 1½	50
P 7040 44	40 x 3,5	G 1½	70
P 7050 44	50 x 4	G 1½	70
P 7040 45	40 x 3,5	G 2	40
P 7050 45	50 x 4	G 2	70
P 7063 46	63 x 4,5	G 2½	70

HERZ - prechodový závitový spoj s kužeľovým tesnením, s prevlečnou maticou,

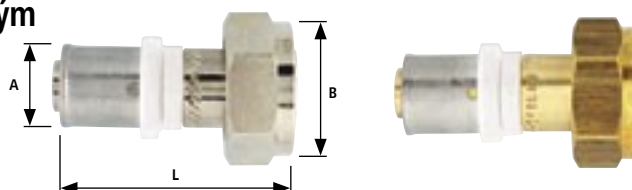

Objednávacie číslo	A	B	L	Vyhotovenie
P 7014 86	14 x 2	M 22 x 1,5	50	poniklované
P 7016 86	16 x 2	M 22 x 1,5	50	
P 7018 86	18 x 2	M 22 x 1,5	50	
P 7020 86	20 x 2	M 22 x 1,5	50	
P 7014 90	14 x 2	G 1/2	50	
P 7016 90	16 x 2	G 1/2	50	
P 7018 90	18 x 2	G 1/2	50	
P 7020 90	20 x 2	G 1/2	50	
P 7014 82	14 x 2	G 3/4	50	
P 7016 82	16 x 2	G 3/4	50	
P 7018 82	18 x 2	G 3/4	50	
P 7020 82	20 x 2	G 3/4	50	
P 7014 81	14 x 2	G 3/4	50	bez poniklovania
P 7016 81	16 x 2	G 3/4	50	
P 7018 81	18 x 2	G 3/4	50	
P 7020 81	20 x 2	G 3/4	50	

HERZ - koleno so závitovým pripojením

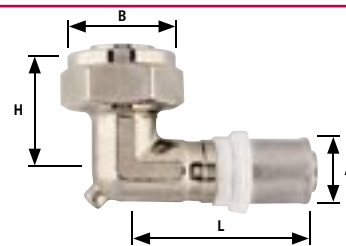

Objednávacie číslo	A	B	L	H
P 7114 14	14 x 2	G 3/4	45	30
P 7116 14	16 x 2	G 3/4	45	30
P 7118 14	18 x 2	G 3/4	50	30
P 7120 14	20 x 2	G 3/4	50	30

HERZ - spojka, spojka redukovaná



Objednávacie číslo	A	B	L
P 7010 00	10 x 1,3	10 x 1,3	41
P 7014 00	14 x 2	14 x 2	65
P 7016 00	16 x 2	16 x 2	58
P 7016 01	16 x 2	14 x 2	65
P 7018 00	18 x 2	18 x 2	65
P 7018 01	18 x 2	14 x 2	65
P 7018 02	18 x 2	16 x 2	65
P 7020 00	20 x 2	20 x 2	58
P 7020 03	20 x 2	14 x 2	62
P 7020 01	20 x 2	16 x 2	62
P 7020 02	20 x 2	18 x 2	65
P 7026 00	26 x 3	26 x 3	65
P 7026 01	26 x 3	16 x 2	65
P 7026 03	26 x 3	17 x 2	65
P 7026 05	26 x 3	18 x 2	65
P 7026 02	26 x 3	20 x 2	65
P 7032 00	32 x 3	32 x 3	65
P 7032 01	32 x 3	16 x 2	65
P 7032 07	32 x 3	18 x 2	65
P 7032 02	32 x 3	20 x 2	65
P 7032 06	32 x 3	26 x 3	65
P 7040 00	40 x 3,5	40 x 3,5	65
P 7040 02	40 x 3,5	26 x 3	65
P 7040 03	40 x 3,5	32 x 3	65
P 7050 00	50 x 4	50 x 4	97
P 7050 01	50 x 4	26 x 3	81
P 7050 02	50 x 4	32 x 3	81
P 7050 03	50 x 4	40 x 3,5	81
P 7063 00	63 x 4,5	63 x 4,5	98
P 7063 01	63 x 4,5	26 x 3	82
P 7063 02	63 x 4,5	32 x 3	82
P 7063 03	63 x 4,5	40 x 3,5	82
P 7063 04	63 x 4,5	50 x 4	98
P 7075 00 *	75 x 5	75 x 5	98
P 7075 01 *	75 x 5	63 x 4,5	98

HERZ - redukcia

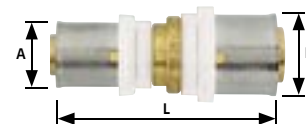

Objednávacie číslo	A	B	L
P 7016 01	16 x 2	14 x 2	65
P 7018 01	18 x 2	14 x 2	65
P 7018 02	18 x 2	16 x 2	65
P 7020 03	20 x 2	14 x 2	65
P 7020 01	20 x 2	16 x 2	65
P 7020 02	20 x 2	18 x 2	65
P 7026 01	26 x 3	16 x 2	65
P 7026 05	26 x 3	18 x 2	65
P 7026 02	26 x 3	20 x 2	65
P 7032 01	32 x 3	16 x 2	65
P 7032 07	32 x 3	18 x 2	65
P 7032 02	32 x 3	20 x 2	65
P 7032 06	32 x 3	26 x 3	65
P 7040 02	40 x 3,5	26 x 3	65
P 7040 03	40 x 3,5	32 x 3	65
P 7050 01	50 x 4	26 x 3	80
P 7050 02	50 x 4	32 x 3	80
P 7050 03	50 x 4	40 x 3,5	80
P 7063 01	63 x 4,5	26 x 3	85
P 7063 02	63 x 4,5	32 x 3	85
P 7063 03	63 x 4,5	40 x 3,5	85
P 7063 04	63 x 4,5	50 x 4	85

HERZ - guľový kohút s pákovým ovládačom a lisovanými spojmi

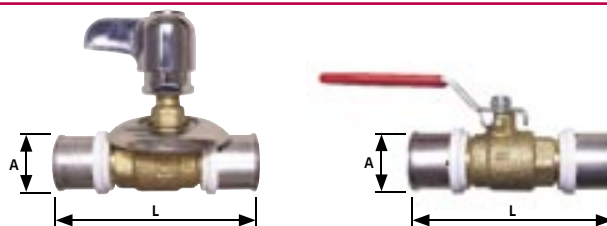

Objednávacie číslo	A	L
P 7216 62	16 x 2	100
P 7218 62	18 x 2	100
P 7220 62	20 x 2	100
P 7226 62	26 x 3	100
P 7216 63	16 x 2	100
P 7220 63	20 x 2	100
P 7226 63	26 x 3	100

HERZ - T-kus

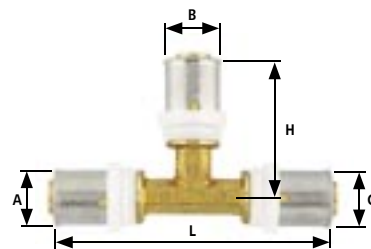

Objednávacie číslo	A	B	C	L	H
P 7214 00	14 x 2	14 x 2	14 x 2	83	42
P 7214 01	14 x 2	16 x 2	14 x 2	83	42
P 7216 00	16 x 2	16 x 2	16 x 2	77	39
P 7216 01	16 x 2	14 x 2	16 x 2	83	42
P 7216 05	16 x 2	18 x 2	16 x 2	88	44
P 7216 03	16 x 2	20 x 2	16 x 2	83	42
P 7217 00	17 x 2	17 x 2	17 x 2	107	54
P 7218 00	18 x 2	18 x 2	18 x 2	83	42
P 7218 01	18 x 2	14 x 2	18 x 2	88	44
P 7218 02	18 x 2	16 x 2	18 x 2	88	44
P 7220 00	20 x 2	20 x 2	20 x 2	83	42
P 7210 00	20 x 2	10 x 1,3	20 x 2	88	33
P 7220 10	20 x 2	14 x 2	20 x 2	88	44
P 7220 02	20 x 2	18 x 2	20 x 2	88	44
P 7220 06	20 x 2	26 x 3	20 x 2	102	51
P 7220 01	20 x 2	16 x 2	20 x 2	83	42
P 7220 03	20 x 2	16 x 2	16 x 2	83	42
P 7220 08	20 x 2	20 x 2	16 x 2	83	42
P 7226 00	26 x 3	26 x 3	26 x 3	102	51
P 7226 17	26 x 3	32 x 3	26 x 3	106	53
P 7226 03	26 x 3	16 x 2	26 x 3	97	49
P 7226 04	26 x 3	18 x 2	26 x 3	102	51
P 7226 05	26 x 3	20 x 2	26 x 3	97	49
P 7232 00	32 x 3	32 x 3	32 x 3	106	53
P 7232 10	32 x 3	40 x 3,5	32 x 3	106	53
P 7232 01	32 x 3	16 x 2	32 x 3	106	53
P 7232 03	32 x 3	18 x 2	32 x 3	106	53
P 7232 04	32 x 3	20 x 2	32 x 3	106	53
P 7232 07	32 x 3	26 x 3	32 x 3	106	53
P 7240 00	40 x 3,5	40 x 3,5	40 x 3,5	110	55
P 7240 12	40 x 3,5	50 x 4	40 x 3,5	120	76
P 7240 02	40 x 3,5	26 x 3	40 x 3,5	110	55
P 7240 03	40 x 3,5	32 x 3	40 x 3,5	110	55
P 7250 00	50 x 4	50 x 4	50 x 4	152	76
P 7250 03	50 x 4	26 x 3	50 x 4	152	62
P 7250 01	50 x 4	32 x 3	50 x 4	152	62
P 7250 02	50 x 4	40 x 3,5	50 x 4	152	61
P 7263 00	63 x 4,5	63 x 4,5	63 x 4,5	166	83
P 7263 01	63 x 4,5	32 x 3	63 x 4,5	166	67
P 7263 02	63 x 4,5	40 x 3,5	63 x 4,5	153	70
P 7263 03	63 x 4,5	50 x 4	63 x 4,5	166	83
P 7275 00 *	75 x 5	75 x 5	75 x 5	190	95

HERZ - záslepka

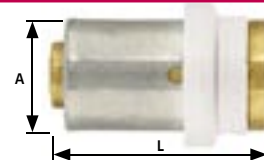

Objednávacie číslo	A	L
P 7014 10	14 x 2	33
P 7016 10	16 x 2	31
P 7017 10	17 x 2	33
P 7018 10	18 x 2	33
P 7020 10	20 x 2	31
P 7026 10	26 x 3	33
P 7032 10	32 x 3	33
P 7040 10	40 x 3,5	33
P 7050 10	50 x 4	49
P 7063 10	63 x 4,5	49

HERZ - T-kus bez križovania

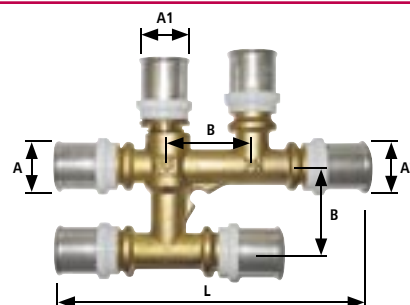

Objednávacie číslo	A	A1	A2	B
P 7216 25	16 x 2	16 x 2	16 x 2	40
P 7220 25	20 x 2	20 x 2	20 x 2	40
P 7220 27	20 x 2	16 x 2	16 x 2	40
P 7220 26	20 x 2	16 x 2	20 x 2	40
P 7220 28	20 x 2	20 x 2	16 x 2	40

HERZ - krabica pre T-kus bez križovania

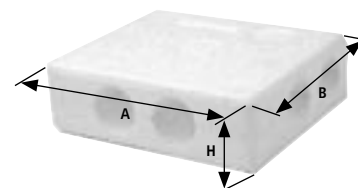

Objednávacie číslo	A	B	H
P 1020 22	120	140	45

HERZ - T-kus, redukovaný

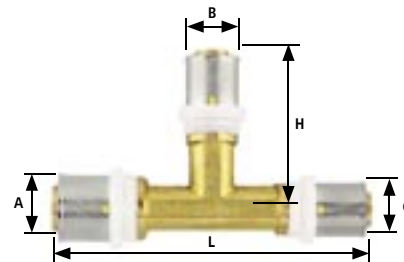

Objednávacie číslo	A	B	C	L	H
P 7216 02	16 x 2	14 x 2	14 x 2	83	42
P 7218 04	18 x 2	16 x 2	14 x 2	107	54
P 7218 03	18 x 2	16 x 2	16 x 2	88	44
P 7220 11	20 x 2	14 x 2	16 x 2	88	44
P 7220 03	20 x 2	16 x 2	16 x 2	83	42
P 7220 07	20 x 2	16 x 2	18 x 2	88	44
P 7220 04	20 x 2	18 x 2	18 x 2	88	44
P 7220 09	20 x 2	20 x 2	14 x 2	88	44
P 7220 08	20 x 2	20 x 2	16 x 2	88	44
P 7226 18	26 x 3	18 x 2	18 x 2	102	51
P 7226 12	26 x 3	18 x 2	20 x 2	102	51
P 7226 13	26 x 3	20 x 2	16 x 2	102	51
P 7226 14	26 x 3	20 x 2	20 x 2	102	51
P 7226 19	26 x 3	20 x 2,5	16 x 2	102	51
P 7226 16	26 x 3	26 x 3	16 x 2	112	56
P 7226 15	26 x 3	26 x 3	20 x 2	112	56
P 7232 11	32 x 3	20 x 2	26 x 3	106	53
P 7232 09	32 x 3	26 x 3	26 x 3	106	53
P 7232 15	32 x 3	32 x 3	20 x 2	106	53
P 7232 14	32 x 3	32 x 3	26 x 3	106	53
P 7240 06	40 x 3,5	26 x 3	32 x 3	110	55
P 7240 04	40 x 3,5	32 x 3	32 x 3	110	50
P 7240 07	40 x 3,5	40 x 3,5	26 x 3	110	55
P 7240 08	40 x 3,5	40 x 3,5	32 x 3	110	55
P 7250 06	50 x 4	32 x 3	40 x 3,5	152	62
P 7250 05	50 x 4	40 x 3,5	40 x 3,5	152	62
P 7250 07	50 x 4	50 x 4	32 x 3	152	76
P 7250 08	50 x 4	50 x 4	40 x 3,5	152	76
P 7263 04	63 x 4,5	40 x 3,5	50 x 4	166	67
P 7263 05	63 x 4,5	50 x 4	50 x 4	166	83
P 7263 06	63 x 4,5	63 x 4,5	40 x 3,5	150	83
P 7263 07	63 x 4,5	63 x 4,5	50 x 4	166	83

HERZ - T-kus s vonkajším závitom

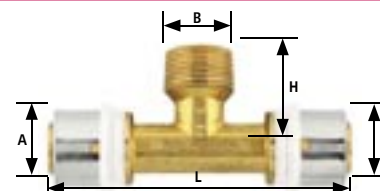

Objednávacie číslo	A	B	C	L	H
P 7216 51	16 x 2	1/2	16 x 2	90	34
P 7218 51	18 x 2	1/2	18 x 2	98	34
P 7220 51	20 x 2	1/2	20 x 2	91	34
P 7226 51	26 x 3	1/2	26 x 3	112	38
P 7220 52	20 x 2	3/4	20 x 2	98	34
P 7226 52	26 x 3	3/4	26 x 3	112	38
P 7232 51	32 x 3	3/4	32 x 3	110	47
P 7226 53	26 x 3	1	26 x 3	112	43
P 7232 52	32 x 3	1	32 x 3	110	47
P 7240 52	40 x 3,5	1	40 x 3,5	110	55
P 7240 53	40 x 3,5	1¼	40 x 3,5	110	55
P 7250 53	50 x 4	1¼	50 x 4	152	61
P 7250 54	50 x 4	1½	50 x 4	152	61
P 7263 54	63 x 4,5	1½	63 x 4,5	166	68
P 7263 55	63 x 4,5	2	63 x 4,5	166	70

HERZ - T-kus s vnútorným závitom

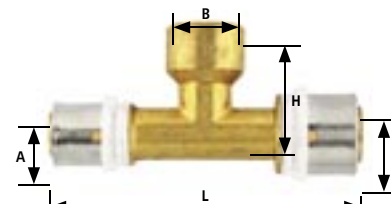

Objednávacie číslo	A	B	C	L	H
P 7216 41	16 x 2	1/2	16 x 2	90	34
P 7218 41	18 x 2	1/2	18 x 2	98	34
P 7220 41	20 x 2	1/2	20 x 2	91	34
P 7226 42	26 x 3	1/2	20 x 2	112	38
P 7226 41	26 x 3	1/2	26 x 3	112	37
P 7232 43	32 x 3	1/2	32 x 3	110	47
P 7220 42	20 x 2	3/4	20 x 2	112	43
P 7226 44	26 x 3	3/4	26 x 3	112	43
P 7232 41	32 x 3	3/4	32 x 3	110	47
P 7232 42	32 x 3	1	32 x 3	110	47
P 7240 41	40 x 3,5	1	40 x 3,5	110	55
P 7232 44	32 x 3	1¼	32 x 3	125	55
P 7240 42	40 x 3,5	1¼	40 x 3,5	110	55
P 7250 42	50 x 4	1¼	50 x 4	152	63
P 7250 43	50 x 4	1½	50 x 4	152	63
P 7263 43	63 x 4,5	1½	63 x 4,5	166	68
P 7263 44	63 x 4,5	2	63 x 4,5	166	70

HERZ - koleno 90°

Objednávacie číslo	A	B	L	H
P 7114 00	14 x 2	14 x 2	42	42
P 7116 00	16 x 2	16 x 2	39	39
P 7118 00	18 x 2	18 x 2	42	42
P 7120 00	20 x 2	20 x 2	42	42
P 7110 00	20 x 2	10 x 1,3	42	33
P 7126 00	26 x 3	26 x 3	49	49
P 7132 00	32 x 3	32 x 3	53	53
P 7140 00	40 x 3,5	40 x 3,5	55	55
P 7150 00	50 x 4	50 x 4	76	76
P 7163 00	63 x 4,5	63 x 4,5	83	83
P 7175 00 *	75 x 5	75 x 5	97	97

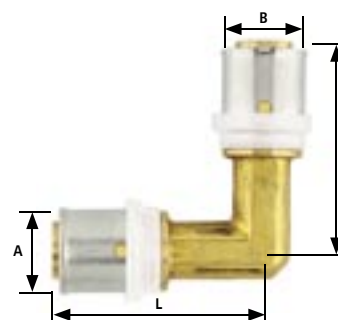

HERZ - koleno so závitovým pripojením

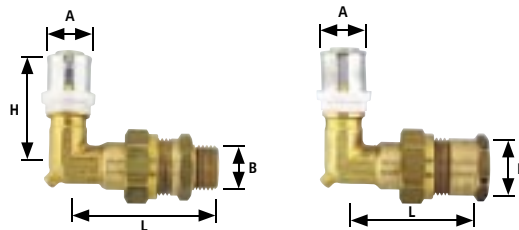

Objednávacie číslo	A	B	L	H
P 7116 71	16 x 2	1/2 AG	70	55
P 7118 71	18 x 2	1/2 AG	70	55
P 7120 71	20 x 2	1/2 AG	70	55
P 7120 72	20 x 2	3/4 AG	70	55
P 7126 73	26 x 3	1 AG	80	55
P 7132 74	32 x 3	1 1/4 AG	95	55
P 7116 81	16 x 2	3/4 IG	65	50
P 7118 81	18 x 2	1/2 IG	65	50
P 7120 81	20 x 2	1/2 IG	65	55
P 7120 82	20 x 2	3/4 IG	65	50
P 7126 83	26 x 3	1 IG	80	55
P 7132 84	32 x 3	1 1/4 IG	100	55

HERZ - lisovaný závitový spoj s plochým tesnením

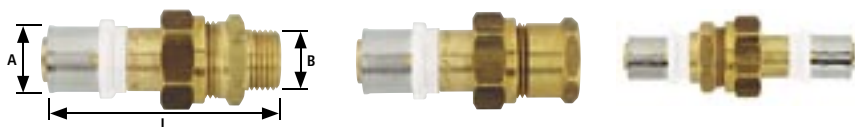

Objednávacie číslo	A	B	L
P 7016 61	16 x 2	1/2 AG	80
P 7018 61	18 x 2	1/2 AG	80
P 7020 61	20 x 2	1/2 AG	80
P 7016 62	16 x 2	3/4 AG	80
P 7018 62	18 x 2	3/4 AG	80
P 7020 62	20 x 2	3/4 AG	80
P 7026 62	26 x 3	3/4 AG	85
P 7026 63	26 x 3	1 AG	85
P 7032 63	32 x 3	1 AG	75
P 7040 64	40 x 3,5	1 1/4 AG	100
P 7050 65	50 x 4	1 1/2 AG	115
P 7063 66	63 x 4,5	2 AG	125
P 7016 71	16 x 2	1/2 IG	75
P 7018 71	18 x 2	1/2 IG	75
P 7020 71	20 x 2	1/2 IG	75
P 7016 72	16 x 2	3/4 IG	80
P 7018 72	18 x 2	3/4 IG	75
P 7020 72	20 x 2	3/4 IG	75
P 7026 72	26 x 3	3/4 IG	85
P 7026 73	26 x 3	1 IG	85
P 7032 73	32 x 3	1 1/4 IG	80
P 7040 74	40 x 3,5	1 IG	100
P 7050 75	50 x 4	1 1/2 IG	120
P 7063 76	63 x 4,5	2 IG	120
P 7016 51	16 x 2	16 x 2	100
P 7018 51	18 x 2	18 x 2	100
P 7020 51	20 x 2	20 x 2	100
P 7026 52	26 x 3	26 x 3	100
P 7032 53	32 x 3	32 x 3	90
P 7040 53	40 x 3,5	40 x 3,5	100
P 7050 55	50 x 4	50 x 4	140
P 7063 56	63 x 4,5	63 x 4,5	160

HERZ - prechod so závitom

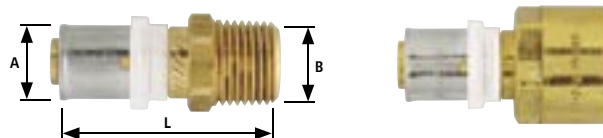

Objednávacie číslo	A	B	L
P 7014 11	14 x 2	R 1/2	45
P 7016 11	16 x 2	R 1/2	45
P 7018 11	18 x 2	R 1/2	45
P 7020 11	20 x 2	R 1/2	45
P 7018 12	18 x 2	R 3/4	45
P 7020 12	20 x 2	R 3/4	45
P 7026 12	26 x 2	R 3/4	45
P 7026 13	26 x 3	R 1	45
P 7032 13	32 x 3	R 1	45
P 7040 13	40 x 3,5	R 1	45
P 7032 14	32 x 3	R 1 1/4	50
P 7040 14	40 x 3,5	R 1 1/4	50
P 7050 14	50 x 4	R 1 1/4	50
P 7050 15	50 x 4	R 1 1/2	50
P 7063 16	63 x 4,5	R 2	65
P 7063 17	63 x 4,5	R 2 1/2	65
P 7014 21	14 x 2	Rp 1/2	45
P 7016 21	16 x 2	Rp 1/2	45
P 7018 21	18 x 2	Rp 1/2	45
P 7020 21	20 x 2	Rp 1/2	45
P 7018 22	18 x 2	Rp 3/4	45
P 7020 22	20 x 2	Rp 3/4	45
P 7026 22	26 x 3	Rp 3/4	45
P 7026 23	26 x 3	Rp 1	45
P 7032 23	32 x 3	Rp 1	50
P 7040 23	40 x 3,5	Rp 1	50
P 7032 24	32 x 3	Rp 1 1/4	50
P 7040 24	40 x 3,5	Rp 1 1/4	50
P 7050 24	50 x 4	Rp 1 1/4	50
P 7050 25	50 x 4	Rp 1 1/2	50
P 7063 26	63 x 4,4	Rp 2	65
P 7063 27	63 x 4,5	Rp 1 1/2	65
P 7075 16	75 x 5	R 2	70
P 7075 18	75 x 5	R 1 1/2	70

HERZ - koleno 45°

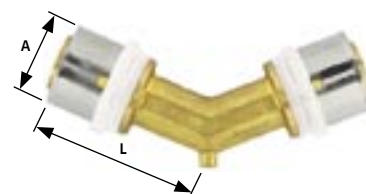

Objednávacie číslo	A	L
P 7126 01	26 x 3	49
P 7132 01	32 x 3	53
P 7140 01	40 x 3,5	55
P 7150 01	50 x 4	76
P 7163 01	63 x 4,5	83

HERZ - T-kus bez križovania, nezmontovaný

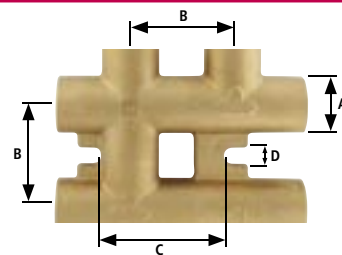

Objednávacie číslo	A	B	C	D
P 7200 31	6 x Rp 1/2	50	70	8

HERZ - závitová spojka

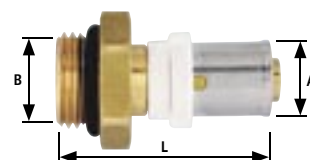

Objednávacie číslo	A	B	L
P 7010 18	10 x 1,3	G 1/2	40
P 7014 18	14 x 2	G 1/2	40
P 7016 18	16 x 2	G 1/2	40
P 7018 18	18 x 2	G 1/2	40
P 7020 18	20 x 2	G 1/2	40
P 7026 18	26 x 3	G 1/2	40

HERZ - krabica pre T-kus bez križovania

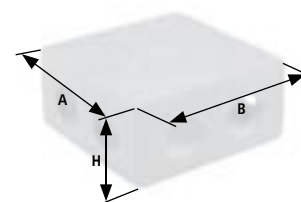

Objednávacie číslo	A	B	H
P 1020 21	120	120	60

Pressfittinge Dimension 75 mm sind geprüft mit Rohr Fabrikat Valsir. Abmessungen auch gültig für Fittinge für Gasanlagen und PUSH-FIX.